

IT'S THE YEAR OF
INNOVATION
AT AMERICAN EAGLE
MANUFACTURING

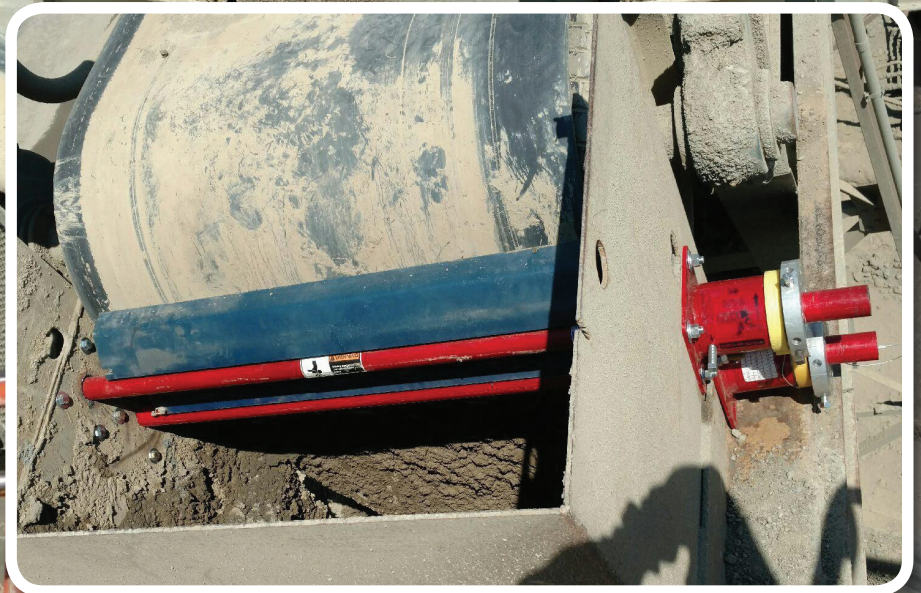

BELT CLEANING TECHNOLOGIES
AND
CONVEYOR ACCESSORIES



PRIMARY CLEANERS

Why should American Eagle be *Your* belt cleaner of choice?

Our patented Eagle Torsion system was designed around a heavy-duty stainless steel spring, which provides even and positive tension, unlike those of our competitors.

Instead of using inaccurate, pre-located holes, you'll have the option of a full 360 degree adjustment, allowing for increased accuracy. Held in place by a heavy duty tab on either side, the spring is set in an Eagle Torsion collar, which can be set to the proper tension using either our own indicator rings or a standard torque wrench. Ease of assembly and installation leads to more productive time for your customer.

AMERICAN EAGLE NOW PRESENTS A NEW ADDITION TO OUR PRIMARY BELT CLEANER LINE.

In addition to the HP/HD series, our Flagship primary belt cleaners with the open spring system, we'd like to introduce the ECT series, with an enclosed spring system, with the same durability and attention to detail you've come to expect from American Eagle.

HP / HD Series

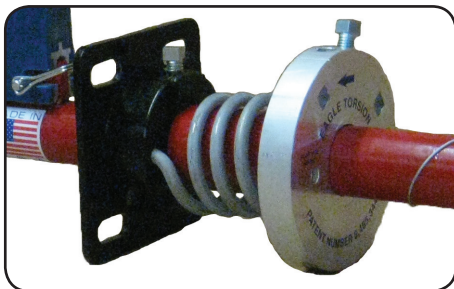

Patent Number
8,485,344

ECT Series

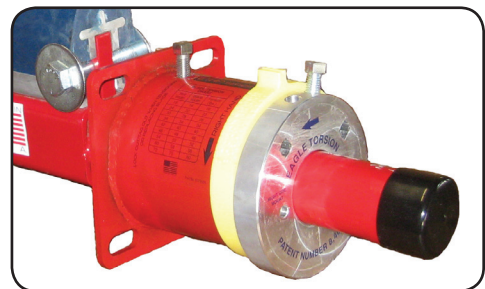

BLADE SELECTION

Blade Material Code

- M** - Ev-R-Wear ●
- U** - Standard ●
- C** - Chemical ●
- H** - High Heat ●
- W** - Food Grade ○

Material meets FDA criteria for the following: CFR21.177.1680

With over 30 years of urethane casting experience, we have developed proprietary blends specifically formulated for the belt cleaning industry.

Selection of the proper blade width is crucial to the life and effectiveness of your blade.

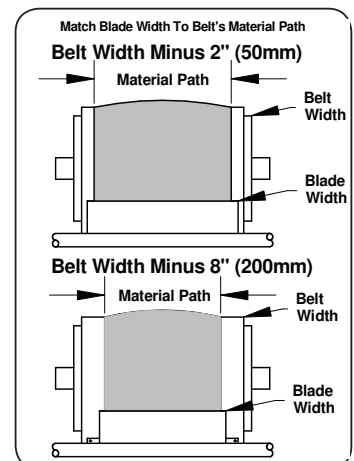

Let our Customer Service team help you select the cleaners that are right for your customer's applications.

PRIMARY CLEANERS

Specifications and Guidelines

Tensioner Type

Eagle Covered Torsion System

Blade Height 4-1/2"

Pulley Diameter

8" to 16" (200 to 400 mm)

Belt Speed

Max 800 FPM (5m/sec)

Temperature Rating

-30°F to 212°F (-35°C to 100°C)

MECT5HP Series



Belt Width	-2 Blade Width	Part Number	-8 Blade Width	Part Number
18"	16"	MECT5HPCSM18	10"	MECT5HPCSM18-8
24"	22"	MECT5HPCSM24	16"	MECT5HPCSM24-8
30"	28"	MECT5HPCSM30	22"	MECT5HPCSM30-8
36"	34"	MECT5HPCSM36	28"	MECT5HPCSM36-8
42"	40"	MECT5HPCSM42	34"	MECT5HPCSM42-8
48"	46"	MECT5HPCSM48	40"	MECT5HPCSM48-8
54"	52"	MECT5HPCSM54	46"	MECT5HPCSM54-8
60"	58"	MECT5HPCSM60	52"	MECT5HPCSM60-8
72"	70"	MECT5HPCSM72	64"	MECT5HPCSM72-8

Specifications and Guidelines

Tensioner Type

Eagle Covered Torsion System

Blade Height 6"

Pulley Diameter

10" to 24" (250 to 600 mm)

Belt Speed

Max 800 FPM (5m/sec)

Temperature Rating

-30°F to 212°F (-35°C to 100°C)

ECT5HP Series



Belt Width	-2 Blade Width	Part Number	-8 Blade Width	Part Number
18"	16"	ECT5HPCSM18	10"	ECT5HPCSM18-8
24"	22"	ECT5HPCSM24	16"	ECT5HPCSM24-8
30"	28"	ECT5HPCSM30	22"	ECT5HPCSM30-8
36"	34"	ECT5HPCSM36	28"	ECT5HPCSM36-8
42"	40"	ECT5HPCSM42	34"	ECT5HPCSM42-8
48"	46"	ECT5HPCSM48	40"	ECT5HPCSM48-8
54"	52"	ECT5HPCSM54	46"	ECT5HPCSM54-8
60"	58"	ECT5HPCSM60	52"	ECT5HPCSM60-8
72"	70"	ECT5HPCSM72	64"	ECT5HPCSM72-8

Specifications and Guidelines

Tensioner Type

Eagle Covered Torsion System

Blade Height 6-5/8"

Pulley Diameter

24" Plus (600 mm +)

Belt Speed

Max 1200 FPM (5m/sec)

Temperature Rating

-30°F to 212°F (-35°C to 100°C)

ECT1HP Series

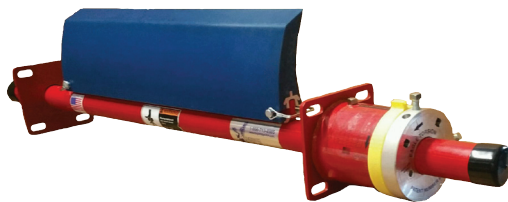

Belt Width	-2 Blade Width	Part Number	-8 Blade Width	Part Number
18"	16"	ECT1HPCSM18	10"	ECT1HPCSM18-8
24"	22"	ECT1HPCSM24	16"	ECT1HPCSM24-8
30"	28"	ECT1HPCSM30	22"	ECT1HPCSM30-8
36"	34"	ECT1HPCSM36	28"	ECT1HPCSM36-8
42"	40"	ECT1HPCSM42	34"	ECT1HPCSM42-8
48"	46"	ECT1HPCSM48	40"	ECT1HPCSM48-8
54"	52"	ECT1HPCSM54	46"	ECT1HPCSM54-8
60"	58"	ECT1HPCSM60	52"	ECT1HPCSM60-8
72"	70"	ECT1HPCSM72	64"	ECT1HPCSM72-8

Specifications and Guidelines

Tensioner Type

Eagle Covered Torsion System

Blade Height 7-1/2"

Pulley Diameter

30" Plus (750 mm +)

Belt Speed

Max 1200 FPM (5m/sec)

Temperature Rating

-30°F to 212°F (-35°C to 100°C)

ECT4HD Series

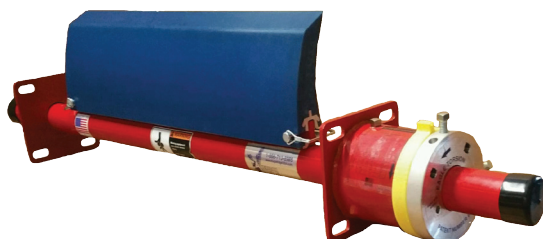

Belt Width	-2 Blade Width	Part Number	-8 Blade Width	Part Number
18"	16"	ECT4HDCSM18	10"	ECT4HDCSM18-8
24"	22"	ECT4HDCSM24	16"	ECT4HDCSM24-8
30"	28"	ECT4HDCSM30	22"	ECT4HDCSM30-8
36"	34"	ECT4HDCSM36	28"	ECT4HDCSM36-8
42"	40"	ECT4HDCSM42	34"	ECT4HDCSM42-8
48"	46"	ECT4HDCSM48	40"	ECT4HDCSM48-8
54"	52"	ECT4HDCSM54	46"	ECT4HDCSM54-8
60"	58"	ECT4HDCSM60	52"	ECT4HDCSM60-8
72"	70"	ECT4HDCSM72	64"	ECT4HDCSM72-8

PRIMARY CLEANERS

Specifications and Guidelines

Tensioner Type

Eagle Covered Torsion System

Blade Height 11"

Pulley Diameter

36" Plus (900 mm +)

Belt Speed

Max 1500 FPM (5m/sec)

Temperature Rating

-30°F to 212°F (-35°C to 100°C)

ECT11XHD Series

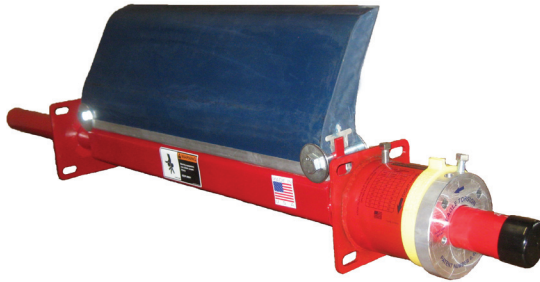

Belt Width	-6 Blade Width	Part Number	-12 Blade Width	Part Number
18"	12"	ECT11XHDCSM18	N/A	N/A
24"	18"	ECT11XHDCSM24	12"	ECT11XHDCSM24-12
30"	24"	ECT11XHDCSM30	28"	ECT11XHDCSM30-12
36"	30"	ECT11XHDCSM36	24"	ECT11XHDCSM36-12
42"	36"	ECT11XHDCSM42	30"	ECT11XHDCSM42-12
48"	42"	ECT11XHDCSM48	36"	ECT11XHDCSM48-12
54"	48"	ECT11XHDCSM54	42"	ECT11XHDCSM54-12
60"	54"	ECT11XHDCSM60	48"	ECT11XHDCSM60-12
72"	66"	ECT11XHDCSM72	60"	ECT11XHDCSM72-12

Specifications and Guidelines

Tensioner Type

Eagle Torsion System

Blade Height 4-1/2"

Pulley Diameter

8" to 16" (200 to 400 mm)

Belt Speed

Max 800 FPM (5m/sec)

Temperature Rating

-30°F to 212°F (-35°C to 100°C)

ME5HP Series

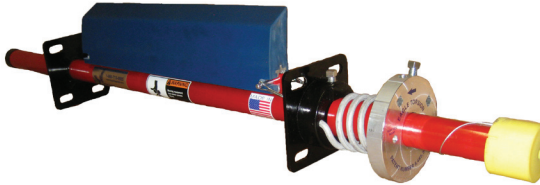

Belt Width	-2 Blade Width	Part Number	-8 Blade Width	Part Number
18"	16"	ME5HPCSM18	10"	ME5HPCSM18-8
24"	22"	ME5HPCSM24	16"	ME5HPCSM24-8
30"	28"	ME5HPCSM30	22"	ME5HPCSM30-8
36"	34"	ME5HPCSM36	28"	ME5HPCSM36-8
42"	40"	ME5HPCSM42	34"	ME5HPCSM42-8
48"	46"	ME5HPCSM48	40"	ME5HPCSM48-8
54"	52"	ME5HPCSM54	46"	ME5HPCSM54-8
60"	58"	ME5HPCSM60	52"	ME5HPCSM60-8
72"	70"	ME5HPCSM72	64"	ME5HPCSM72-8

Specifications and Guidelines

Tensioner Type

Eagle Torsion System

Blade Height 6"

Pulley Diameter

10" to 24" (250 to 600 mm)

Belt Speed

Max 800 FPM (5m/sec)

Temperature Rating

-30°F to 212°F (-35°C to 100°C)

E5HP Series

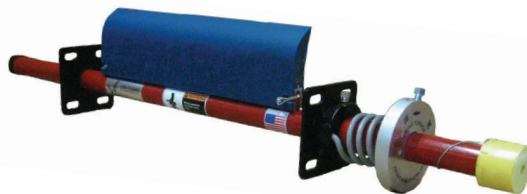

Belt Width	-2 Blade Width	Part Number	-8 Blade Width	Part Number
18"	16"	E5HPCSM18	10"	E5HPCSM18-8
24"	22"	E5HPCSM24	16"	E5HPCSM24-8
30"	28"	E5HPCSM30	22"	E5HPCSM30-8
36"	34"	E5HPCSM36	28"	E5HPCSM36-8
42"	40"	E5HPCSM42	34"	E5HPCSM42-8
48"	46"	E5HPCSM48	40"	E5HPCSM48-8
54"	52"	E5HPCSM54	46"	E5HPCSM54-8
60"	58"	E5HPCSM60	52"	E5HPCSM60-8
72"	70"	E5HPCSM72	64"	E5HPCSM72-8

Specifications and Guidelines

Tensioner Type

Eagle Torsion System

Blade Height 6-5/8"

Pulley Diameter

24" Plus (600 mm +)

Belt Speed

Max 1200 FPM (5m/sec)

Temperature Rating

-30°F to 212°F (-35°C to 100°C)

E1HP Series

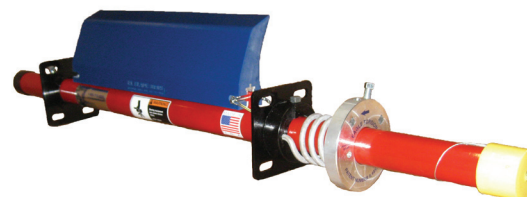

Belt Width	-2 Blade Width	Part Number	-8 Blade Width	Part Number
18"	16"	E1HPCSM18	10"	E1HPCSM18-8
24"	22"	E1HPCSM24	16"	E1HPCSM24-8
30"	28"	E1HPCSM30	22"	E1HPCSM30-8
36"	34"	E1HPCSM36	28"	E1HPCSM36-8
42"	40"	E1HPCSM42	34"	E1HPCSM42-8
48"	46"	E1HPCSM48	40"	E1HPCSM48-8
54"	52"	E1HPCSM54	46"	E1HPCSM54-8
60"	58"	E1HPCSM60	52"	E1HPCSM60-8
72"	70"	E1HPCSM72	64"	E1HPCSM72-8

PRIMARY CLEANERS

Designed and built with the same quality and attention to detail that you've come to expect from American Eagle, our Economy line was developed with your customer's budget in mind.

These cleaners feature the same mounting tubes and blades as our other primary cleaners, with the Eagle Torque hand tensioner replacing the Eagle Torsion spring tensioners. It's an inexpensive solution to solve a very expensive problem.

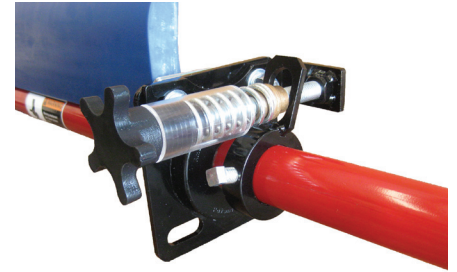

Specifications and Guidelines

Tensioner Type

Eagle Torque System

Blade Height 4-1/2"

Pulley Diameter

8" to 16" (200 to 400 mm)

Belt Speed

Max 500 FPM (5m/sec)

Temperature Rating

-30°F to 212°F (-35°C to 100°C)

ME5 Series

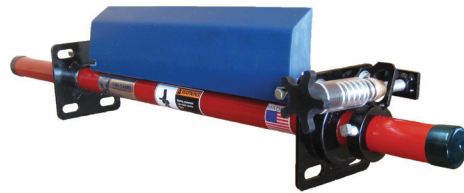

Belt Width	-2 Blade Width	Part Number	-8 Blade Width	Part Number
18"	16"	ME5CSM18	10"	ME5CSM18-8
24"	22"	ME5CSM24	16"	ME5CSM24-8
30"	28"	ME5CSM30	22"	ME5CSM30-8
36"	34"	ME5CSM36	28"	ME5CSM36-8
42"	40"	ME5CSM42	34"	ME5CSM42-8
48"	46"	ME5CSM48	40"	ME5CSM48-8
54"	52"	ME5CSM54	46"	ME5CSM54-8
60"	58"	ME5CSM60	52"	ME5CSM60-8
72"	70"	ME5CSM72	64"	ME5CSM72-8

Specifications and Guidelines

Tensioner Type

Eagle Torque System

Blade Height 6"

Pulley Diameter

10" to 24" (250 to 600 mm)

Belt Speed

Max 500 FPM (5m/sec)

Temperature Rating

-30°F to 212°F (-35°C to 100°C)

E5 Series



Belt Width	-2 Blade Width	Part Number	-8 Blade Width	Part Number
18"	16"	E5CSM18	10"	E5CSM18-8
24"	22"	E5CSM24	16"	E5CSM24-8
30"	28"	E5CSM30	22"	E5CSM30-8
36"	34"	E5CSM36	28"	E5CSM36-8
42"	40"	E5CSM42	34"	E5CSM42-8
48"	46"	E5CSM48	40"	E5CSM48-8
54"	52"	E5CSM54	46"	E5CSM54-8
60"	58"	E5CSM60	52"	E5CSM60-8
72"	70"	E5CSM72	64"	E5CSM72-8

Specifications and Guidelines

Tensioner Type

Eagle Torque System

Blade Height 6-5/8"

Pulley Diameter

24" Plus (600 mm +)

Belt Speed

Max 600 FPM (5m/sec)

Temperature Rating

-30°F to 212°F (-35°C to 100°C)

E1 Series



Belt Width	-2 Blade Width	Part Number	-8 Blade Width	Part Number
18"	16"	E1CSM18	10"	E1CSM18-8
24"	22"	E1CSM24	16"	E1CSM24-8
30"	28"	E1CSM30	22"	E1CSM30-8
36"	34"	E1CSM36	28"	E1CSM36-8
42"	40"	E1CSM42	34"	E1CSM42-8
48"	46"	E1CSM48	40"	E1CSM48-8
54"	52"	E1CSM54	46"	E1CSM54-8
60"	58"	E1CSM60	52"	E1CSM60-8
72"	70"	E1CSM72	64"	E1CSM72-8

PRIMARY CLEANER ACCESSORIES

Eagle Safety Inspection Access Door

Eagle Safety Inspection Access Door is designed for chute inspection and easier maintenance of primary cleaners, including blade change-out. Constructed of all steel, the doors are laser cut, formed and powder coated for a trouble free life.

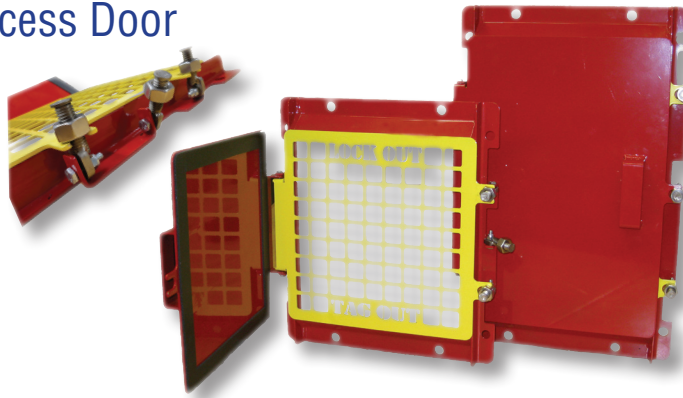

Part Number	Size
ESIAD9x12	9"x12"
ESIAD12x12	12"x12"
ESIAD12x18	12"x18"
ESIAD18x18	18"x18"
ESIAD18x24	18"x24"
ESIAD24x24	24"x24"
ESIAD24x48	24"x48"
ESIAD42x42	42"x42"

Eagle Blade Access Plate

Designed to eliminate a **major safety hazard**, Eagle Blade Access Plate allows removal of the entire primary cleaner as a cartridge from one side of the headbox. This eliminates personnel having to get inside the headbox, creating a safer work environment. By simply removing six bolts on one side and the set collar on the other, two people can change-out the blade and return the cleaner to its operating position quickly and safely.

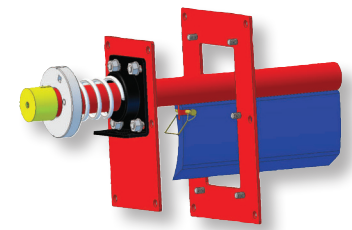

Part Number	Size
EBAP-1	17"x11-1/2"

Universal Telescoping Mount

This low cost mount provides quick installation of primary cleaners, lightening the burden of future maintenance. With our universal cleaner mounting bracket you can mount underneath, on the outside or inside of the telescoping bracket. **No one else offers these options!**

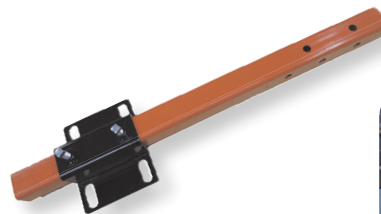

Part Number	Size
UTM30	30"
UTM48	48"

(set of 2)

Eagle Mounting Plate or Chute Patch

This low cost Mounting Plate provides easy installation of primary cleaners without chute walls. It also can be used as a chute patch for new installation of primary or secondary cleaners.

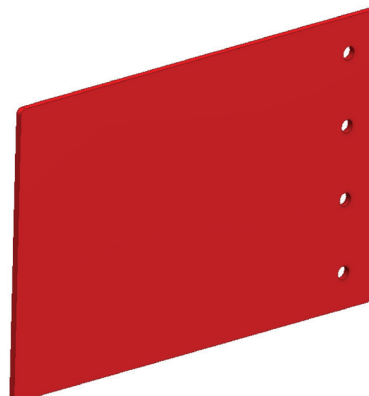

Part Number	Size
EMP1218	12"x18"

(set of 2)

SECONDARY CLEANERS

Specifications and Guidelines

Tensioner Type

Spring Tensioner

Blade Height 7"

Belt Speed

Max 1000 FPM (5m/sec)

Temperature Rating

-30°F to 212°F (-35°C to 100°C)



E8SC Series

Belt Width	Blade Width	Part Number w/Carbide Blade	Blade Width	Part Number w/Urethane Blade
18"	18"	E8SC-M-GC-18	18"	E8SC-M-UR-18
24"	24"	E8SC-M-GC-24	24"	E8SC-M-UR-24
30"	30"	E8SC-M-GC-30	30"	E8SC-M-UR-30
36"	36"	E8SC-M-GC-36	36"	E8SC-M-UR-36
42"	42"	E8SC-M-GC-42	42"	E8SC-M-UR-42
48"	48"	E8SC-M-GC-48	48"	E8SC-M-UR-48
54"	54"	E8SC-M-GC-54	54"	E8SC-M-UR-54
60"	60"	E8SC-M-GC-60	60"	E8SC-M-UR-60
72"	72"	E8SC-M-GC-72	72"	E8SC-M-UR-72

Specifications and Guidelines

Tensioner Type

Hand Tensioner

Blade Height 5"

Belt Speed

Max 1000 FPM (5m/sec)

Temperature Rating

-30°F to 212°F (-35°C to 100°C)



NS7SC Series

Designed for narrow spaces.

Belt Width	Blade Width	Part Number w/Carbide Blade	Blade Width	Part Number w/Urethane Blade
18"	18"	NS7SC-M-GC5-18	18"	NS7SC-M-UR5-18
24"	24"	NS7SC-M-GC5-24	24"	NS7SC-M-UR5-24
30"	30"	NS7SC-M-GC5-30	30"	NS7SC-M-UR5-30
36"	36"	NS7SC-M-GC5-36	36"	NS7SC-M-UR5-36
42"	42"	NS7SC-M-GC5-42	42"	NS7SC-M-UR5-42
48"	48"	NS7SC-M-GC5-48	48"	NS7SC-M-UR5-48
54"	54"	NS7SC-M-GC5-54	54"	NS7SC-M-UR5-54
60"	60"	NS7SC-M-GC5-60	60"	NS7SC-M-UR5-60
72"	72"	NS7SC-M-GC5-72	72"	NS7SC-M-UR5-72

Specifications and Guidelines

Tensioner Type

Hand Tensioner

Blade Height 7"

Belt Speed

Max 1000 FPM (5m/sec)

Temperature Rating

-30°F to 212°F (-35°C to 100°C)

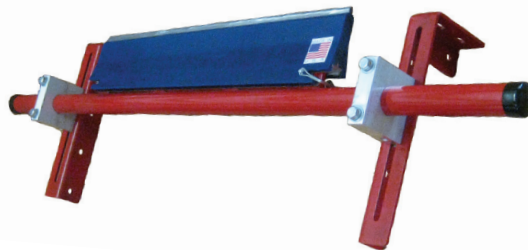

E7SC Series

Belt Width	Blade Width	Part Number w/Carbide Blade	Blade Width	Part Number w/Urethane Blade
18"	18"	E7SC-M-GC-18	18"	E7SC-M-UR-18
24"	24"	E7SC-M-GC-24	24"	E7SC-M-UR-24
30"	30"	E7SC-M-GC-30	30"	E7SC-M-UR-30
36"	36"	E7SC-M-GC-36	36"	E7SC-M-UR-36
42"	42"	E7SC-M-GC-42	42"	E7SC-M-UR-42
48"	48"	E7SC-M-GC-48	48"	E7SC-M-UR-48
54"	54"	E7SC-M-GC-54	54"	E7SC-M-UR-54
60"	60"	E7SC-M-GC-60	60"	E7SC-M-UR-60
72"	72"	E7SC-M-GC-72	72"	E7SC-M-UR-72

THE SINGLE BLADE ADVANTAGE

Our Eagle Secondary cleaners are constructed with a single blade. It's another thing that sets us apart from our competitors. But why?

- The blade is guaranteed to be the perfect height from manufacturing through installation.
- Unlike segmented blades, a single blade will allow for no gaps in belt coverage.
- No Assembly Necessary! No cartridges, no trouble...easy installation of replacements with only one pin.

Secondary Blade Options

- Tungsten Carbide
- Solid Urethane
- AR400

SECONDARY CLEANERS

Specifications and Guidelines

Tensioner Type

Hand Tensioner

PolyStar Diameter 8"

Belt Speed

Max 1000 FPM (5m/sec)

Temperature Rating

-30°F to 212°F (-35°C to 100°C)

PMSC Series PolyStar Multipurpose

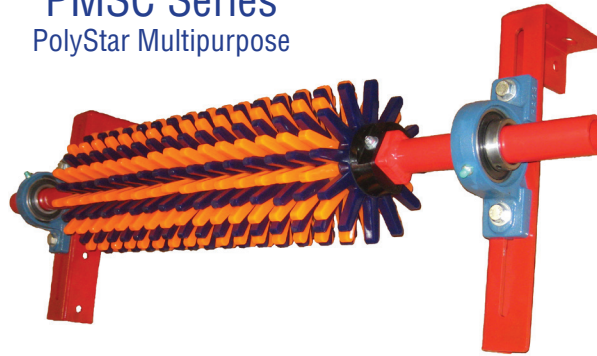

Belt Width	Part Number
18"	PMSC18
24"	PMSC24
30"	PMSC30
36"	PMSC36
42"	PMSC42
48"	PMSC48
54"	PMSC54
60"	PMSC60
72"	PMSC72

Specifications and Guidelines

Tensioner Type

Hand Tensioner

PolyStar Diameter 8"

Belt Speed

Max 1000 FPM (5m/sec)

Temperature Rating

-30°F to 212°F (-35°C to 100°C)

PMDSC Series PolyStar Multipurpose w/Access Door

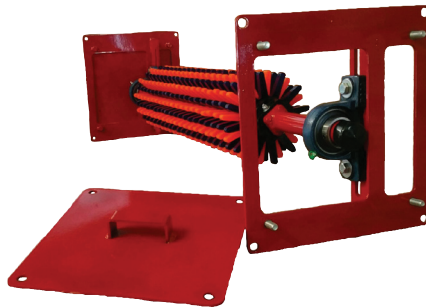

Bracket is designed into the access door for easy adjustment and maintenance.

Belt Width	Part Number
18"	PMDSC18
24"	PMDSC24
30"	PMDSC30
36"	PMDSC36
42"	PMDSC42
48"	PMDSC48
54"	PMDSC54
60"	PMDSC60
72"	PMDSC72

Specifications and Guidelines

Tensioner Type

Self Adjusting

Blade Height 4" or 6"

Belt Speed

Max 1000 FPM (5m/sec)

Temperature Rating

-30°F to 212°F (-35°C to 100°C)

E3 VPlow Series



Belt Width	Part Number w/4" Blade	Belt Width	Part Number w/6" Blade
18"	E3VP18-4	18"	E3VP18-6
24"	E3VP24-4	24"	E3VP24-6
30"	E3VP30-4	30"	E3VP30-6
36"	E3VP36-4	36"	E3VP36-6
42"	E3VP42-4	42"	E3VP42-6
48"	E3VP48-4	48"	E3VP48-6
54"	E3VP54-4	54"	E3VP54-6
60"	E3VP60-4	60"	E3VP60-6
72"	E3VP72-4	72"	E3VP72-6

Specifications and Guidelines

Tensioner Type

Self Adjusting

Blade Height 4" or 6"

Belt Speed

Max 1000 FPM (5m/sec)

Temperature Rating

-30°F to 212°F (-35°C to 100°C)

E9 Diagonal Series



Belt Width	Part Number w/4" Blade	Belt Width	Part Number w/6" Blade
18"	E9DP18-4	18"	E9DP18-6
24"	E9DP24-4	24"	E9DP24-6
30"	E9DP30-4	30"	E9DP30-6
36"	E9DP36-4	36"	E9DP36-6
42"	E9DP42-4	42"	E9DP42-6
48"	E9DP48-4	48"	E9DP48-6
54"	E9DP54-4	54"	E9DP54-6
60"	E9DP60-4	60"	E9DP60-6
72"	E9DP72-4	72"	E9DP72-6

SECONDARY CLEANER ACCESSORIES

Hold Down Roller

A hold down roller is required when the belt is cupping off the head pulley or when the secondary cleaner is over 10" from head pulley.

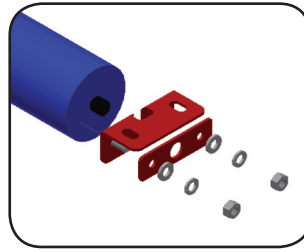

Belt Width	5" Roller with Brackets	6" Roller with Brackets
24"	EHDR5-24	EHDR6-24
30"	EHDR5-30	EHDR6-30
36"	EHDR5-36	EHDR6-36
42"	EHDR5-42	EHDR6-42
48"	EHDR5-48	EHDR6-48
54"	EHDR5-54	EHDR6-54
60"	EHDR5-60	EHDR6-60
72"	EHDR5-72	EHDR6-72

Mounting Bracket for E8 Series

Our mounting bracket will allow you to mount our E8SC series belt cleaner in an area where there is no chute wall or where more room is required for proper belt cleaner installation.

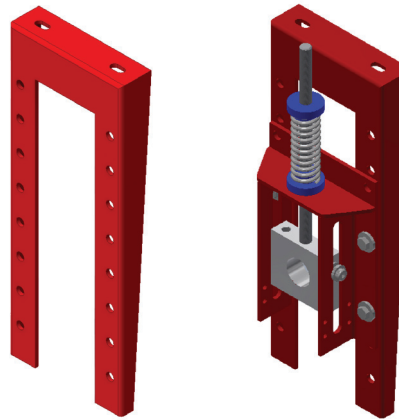

Part Number	Size
E8SCMB24	24"

(set of 2)

E8SC Belt Cleaner not included

Bottom Mounting Bracket for E8 Series

Our bottom mounting bracket is designed to retrofit an existing E8SC series belt cleaner to be tensioned from the bottom.

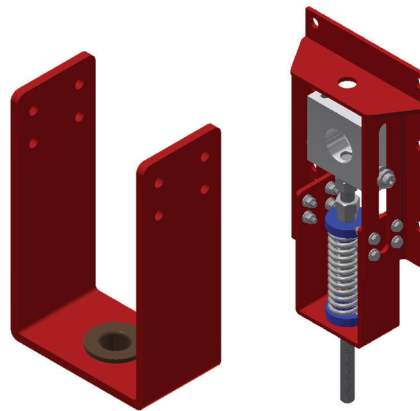

Part Number	Size
E8SCBMB	8"

(set of 2)

E8SC Belt Cleaner not included

Eagle Mounting Plate or Chute Patch

This low cost Mounting Plate provides easy installation of primary cleaners without chute walls. It also can be used as a chute patch for new installation of primary or secondary cleaners.

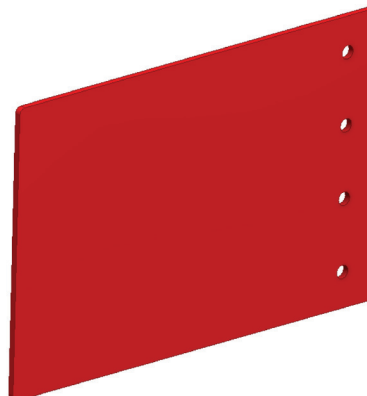

Part Number	Size
EMP1218	12"x18"

(set of 2)

REPLACEMENT BLADES

American Eagle Manufacturing LLC is the world leader in blade technology. Our advanced processing equipment gives us a unique edge in compounding capabilities. We use only premium urethane resins along with specific additives to achieve a superior blade product. We pride ourselves with 35 years of molding experience and constant new product development. Our experience in material application over a broad industry background gives us the leading edge in BLADE TECHNOLOGY.

Ev-R-Wear™ Primary Blades

American Eagle is a premier manufacturer of high performance replacement belt cleaner blades and scrapers. Our blades are engineered to offer high resistance to abrasion with low friction additives that extends the life of our blades in the most challenging applications.

American Eagle offers replacement blades for most major cleaner manufacturers.

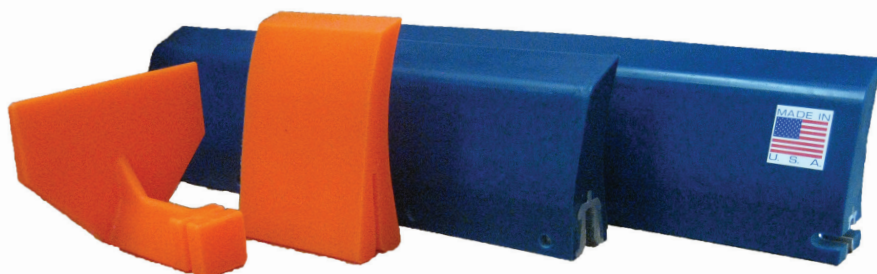

Blade Material Options

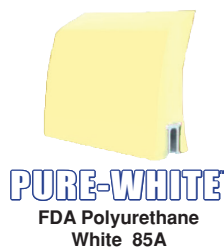

Secondary Blades

American Eagle's Blade Design is not only for our product line but will retrofit most OEM Secondary Belt Cleaners.

Our single blade design will not damage your belt like segmented blades. No need for fancy, expensive cartridges like other OEMs, just pull one pin, blade and replace.

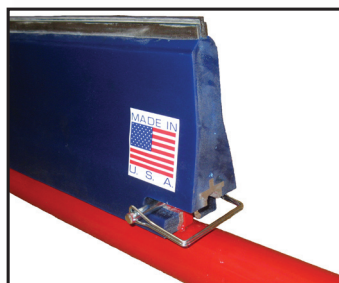
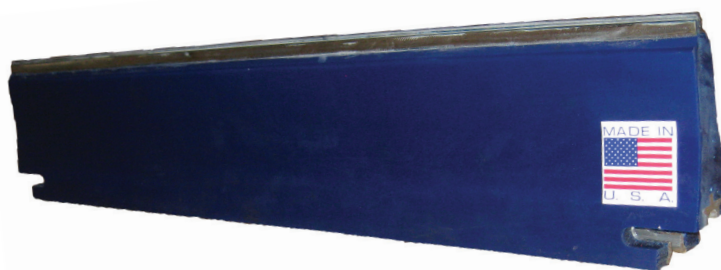

Secondary Blade Options

- Tungsten Carbide
- Solid Urethane
- AR400

BELT ALIGNMENT

Belt Alignment Roller/Eagle Commander

Eagle commander is designed to persuade your belt to track on center of your conveyor rollers. As the belt starts to track off to one side the Eagle Commander roller cams to lift the belt up on that side to persuade the belt back on center.

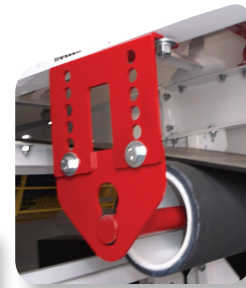

Part Number	Belt Width
ECAR-24	24"
ECAR-30	30"
ECAR-36	36"
ECAR-42	42"
ECAR-48	48"
ECAR-54	54"
ECAR-60	60"
ECAR-72	72"

Eagle Alignment Disks

Eagle Alignment Disks are designed to protect a mistracking belt from rubbing against a conveyor frame work, protecting from any side damage. Since the disks are always rotating, the belt moves with the disk instead of rubbing against the roller brackets. This will extend the life of your belt and help reduce both side tear and premature belt failures.



Part Number	Idler O.D.	Disk O.D.
EAD04090	4	9
EAD04012	4	12
EAD45090	4-1/2	9
EAD45012	4-1/2	12
EAD05090	5	9
EAD05012	5	12
EAD06090	6	9
EAD06012	6	12

Product is best suited for lightweight belts that are no more than 1/2" thick and 42" wide.

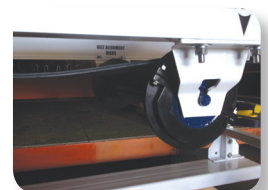

SAFETY PRYBAR SLEEVE

Our Safety Prybar Sleeve is designed to eliminate prybars falling through or rolling off an overhead steel grate walkway. The outer dimensions are designed larger than MSHA and OSHA overhead steel grate walkway safety codes for size opening.

Part Number Prybar & Sleeve	Part Number Sleeve Only	Hex Size
PBS-1-B	PBS-1	1/2"
PBS-2-B	PBS-2	5/8"
PBS-3-B	PBS-3	11/16"
PBS-4-B	PBS-4	7/8"
PBS-5-B	PBS-5	15/16"
PBS-6-B	PBS-6	1"
PBS-7-B	PBS-7	3/4"

Part Number Prybar & Sleeve	Part Number Sleeve Only	Round Size
PBS-1R-B	PBS-1R	1/2"
PBS-2R-B	PBS-2R	5/8"
PBS-3R-B	PBS-3R	11/16"
PBS-4R-B	PBS-4R	7/8"
PBS-5R-B	PBS-5R	15/16"
PBS-6R-B	PBS-6R	1"
PBS-7R-B	PBS-7R	3/4"

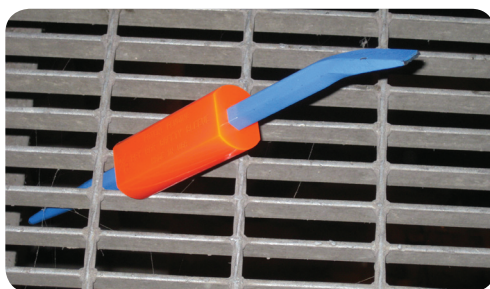

IT'S THE YEAR OF
INNOVATION
AT AMERICAN EAGLE
MANUFACTURING

GLADIATOR BLADE
POLY★STAR™
Ev-R-Wear™
PURE-WHITE™

American Eagle Manufacturing LLC
1 866 713 8985
252 633 0603
New Bern, North Carolina 28562
AmericanEagleManufacturing.com

